

KBIC[®], KBMM[™]

BARRIER TERMINAL BOARDS

KBIC BTB (P/N 9884)
KBMM BTB (P/N 9897)

Converts KBIC[®] and KBMM[™] Controls
from Quick-Connect Terminals to
Barrier Terminals

Contains Provision for AC Line
and Armature Fusing[▲]

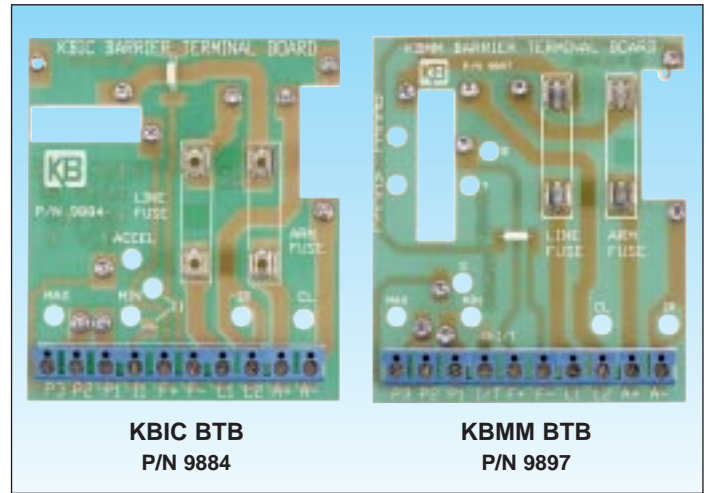

KBIC BTB
P/N 9884

KBMM BTB
P/N 9897

FUSE SELECTION CHART

Motor Horsepower		Approx. Motor Current (DC Amps)	Fuse Rating (AC Amps)	Reorder Kit Part No. 100Pcs/Box
Armature Voltage 90 VDC	Armature Voltage 180 VDC			
1/30	1/15	0.33	1/2	9871
1/20	1/10	0.5	3/4	9872
1/15	1/8	0.65	1	9873
1/12	1/6	0.85	1 1/4	9874
1/8	1/4	1.3	2	9875
1/6	1/3	1.7	2 1/2	9876
1/4	1/2	2.5	4	9877
1/3	3/4	3.3	5	9878
1/2	1	5.0	8*	9879
3/4	1 1/2	7.5	12*	9880
1	2	10.0	15*	9881
1 1/2	3	15.0	25*	9882

▲Also used as AC Line Fuse

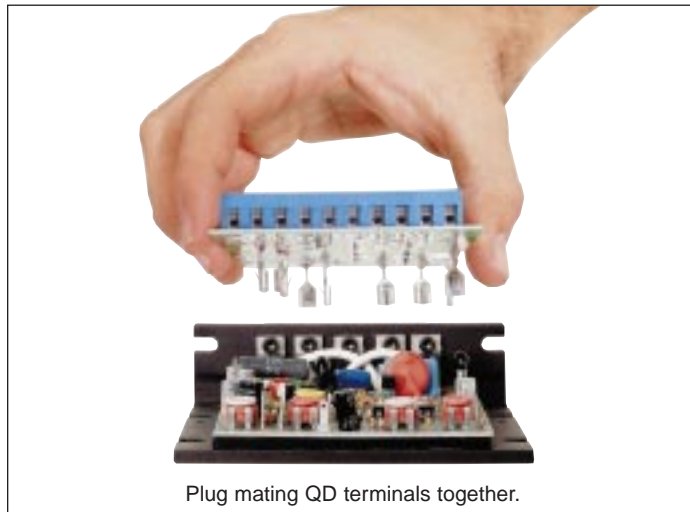

Plug mating QD terminals together.

FUSING

Provision is made for a built-in AC line fuse and armature fuse. The AC line fuse protects the control against catastrophic failure. The armature fuse provides overload protection for the motor and control. Choose the proper size armature fuse by multiplying the maximum DC motor amps by 1.7. Separate branch circuit protection for each ungrounded AC input line must be provided. All fuses should be properly rated for the intended application and all appropriate electrical codes should be followed when wiring this unit.

- The AC Line Fuse can be chosen according to the maximum rating of the control:
8 Amp fuse for all motors to 1/2 Hp-90V and 1 Hp-180VDC.
12 Amp fuse for all motors up to 3/4 Hp-90V and 1 1/2 Hp-180VDC.
15 Amp fuse for all motors up to 1 Hp-90V and 2 Hp-180VDC.
25 Amp fuse for all motors up to 1 1/2 Hp-90V and 3 Hp-180VDC.
(Use Buss ABC, Litt. 326 ceramic fuses or equivalent.)

Note: If the fuse blows, the control is miswired, the motor is shorted or grounded, or the control is defective.

- Armature Fuse can be chosen in accordance with the fuse chart. Note: The armature fuse is calculated based on the approximate full load DC current of the motor times a form factor of 1.5. If the motor has characteristics not consistent with these approximations, a different fuse value may have to be used. Fuses are available from your distributor. Also available is a Fuse Kit (KB P/N 9870) containing 700 assorted fuses.

DESCRIPTION

The KBIC[®] and KBMM[™] Barrier Terminal Boards easily convert a standard control with quick-connect terminals to barrier terminals. Provision is made for AC line and armature fusing. The Barrier Terminal Board installs directly over the control by mating the Q-D terminals. A separate .110" jumper wire can be used to connect to the I1 inhibit terminal or, on the KBMM[™], to the T or B terminals which are used for tach feedback. (Refer to KBMM Instruction Manual.)
Fuses supplied separately.

© 1997 KB Electronics, Inc.